

# Room Alert<sup>®</sup> S Models

Temperature & Environment Monitoring... Made Easy!



User's Guide & Reference Manual

## Copyright Information

© Copyright 1988-2020 AVTECH Software Inc.

All Rights Reserved. No part of this book may be used or reproduced for commercial benefit in any form or by any means, or stored in a database or retrieval system, without prior written permission of AVTECH Software Inc., except in the case of brief quotations embodied in articles and reviews. Making copies of any part of this book for any purpose other than your individual use is a violation of United States copyright laws and international treaty provisions. For information or additional copies, contact AVTECH Software Inc., as directed below. Published in the United States of America.

## Warning and Disclaimer

This publication is shipped as is, without warranty of any kind, either express or implied. While every precaution has been taken in the preparation of this publication, the publisher and authors assume no responsibility for errors or omissions. Neither is any liability assumed for damages resulting from the use of the information or instructions contained herein. It is further stated that the publisher and authors are not responsible for any damage or loss to your data or equipment that may result directly or indirectly from your use of this publication and the related hardware & software. Nothing on any AVTECH website or in documentation shall be construed as conferring any license under any of the AVTECH Software (AVTECH) or any third party's intellectual property rights, whether by estoppel, implication, or otherwise.

## Trademark Acknowledgements

AlertScript, AVTECH, the AVTECH Logo, AVTECH Software, the AVTECH System Manager Character, AVTECH.com, AVTECHSoftware.com, Environment Alarm, "Environment Monitoring Made Easy!", EnvironmentMonitor.com, "IT Environment Monitoring Made Easy!", MUPS, Device Discovery, Device Manager, "Protect Your Facility... Don't Wait Until It's Too Late!", "Protect Your IT Environment... Don't Wait Until It's Too Late!", Room Alert, Room Alert Signal Tower, Signal Tower, RoomAlert.com, RoomAlert.co.uk, RoomAlert.eu, TemPageR, TemPageR.com and "Temperature Monitoring Made Easy!", WiSH, and WiSPR, are trademarks or registered trademarks of AVTECH Software Inc. Any other trademarks, product or company names mentioned herein are the property of their respective owners and used strictly for the purpose of identifying compatibility. AVTECH Software Inc. cannot attest to the accuracy of any other organization's ownership claim to a trademark and use of any trademark in this publication should not be regarded as affecting the validity of any trademark or service mark.

## Contact Us

### Worldwide Headquarters

AVTECH Software, Inc.  
16 Cutler Street, Cutler Mill  
Warren, RI 02885-2761 USA

Visit us on the web at [AVTECH.com](https://AVTECH.com)  
Log in to your account at [RoomAlert.com](https://RoomAlert.com)

### Sales

Need to expand your monitoring capacity? Visit our online store 24/7 at

[https://AVTECH.com/Products/Environment\\_Monitors/](https://AVTECH.com/Products/Environment_Monitors/)

Want expert advice? Contact our Product Specialists Monday to Friday, 9 AM to 5 PM EST (excluding holidays).

#### [Sales@AVTECH.com](mailto:Sales@AVTECH.com)

Quote Request at <https://AVTECH.com/quote/>

Live Sales Chat at <https://AVTECH.com/>

888-220-6700 (In the USA & Canada, toll-free)

401-628-1600 (Outside the USA & Canada)

### Technical Support

Questions about your product? Get answers 24/7 at our online Support Center.

Need more help? Contact our Technical Support Specialists Monday to Friday, 9 AM to 5 PM EST (excluding holidays).

#### [Support@AVTECH.com](mailto:Support@AVTECH.com)

Live Support Chat at <https://AVTECH.com/support/>

888-220-6700 (In the USA & Canada, toll-free)

401-628-1600 (Outside the USA & Canada)

## Table of Contents

Room Alert S Model Hardware Options .....	3
Room Alert 32S.....	3
Room Alert 12S.....	4
Room Alert Hardware Features .....	5
Standard Room Alert Packages.....	6
How To Install Your Room Alert S Model.....	7
Connect Your Room Alert Hardware.....	7
If Your Network Is Power Over Ethernet (PoE) Enabled .....	7
If Your Network Is Not Power Over Ethernet (PoE) Enabled .....	7
Connect External Sensors And Other Compatible Components .....	7
How To Use Your Room Alert S Model Web Interface .....	8
Status.....	8
Banner & Header.....	9
Sensor Display Area .....	10
Settings .....	12
Sensors .....	14
Alarms.....	21
Network.....	25
Email.....	28
SNMP .....	30
Security .....	33
Advanced .....	34
For More Information .....	37

## Room Alert S Model Hardware Options

### Room Alert 32S

#### Front

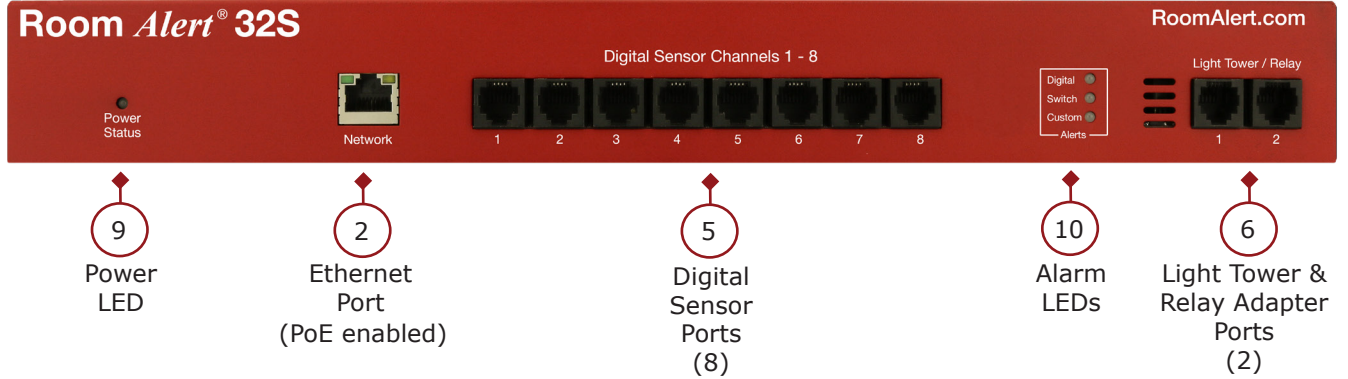

#### Back

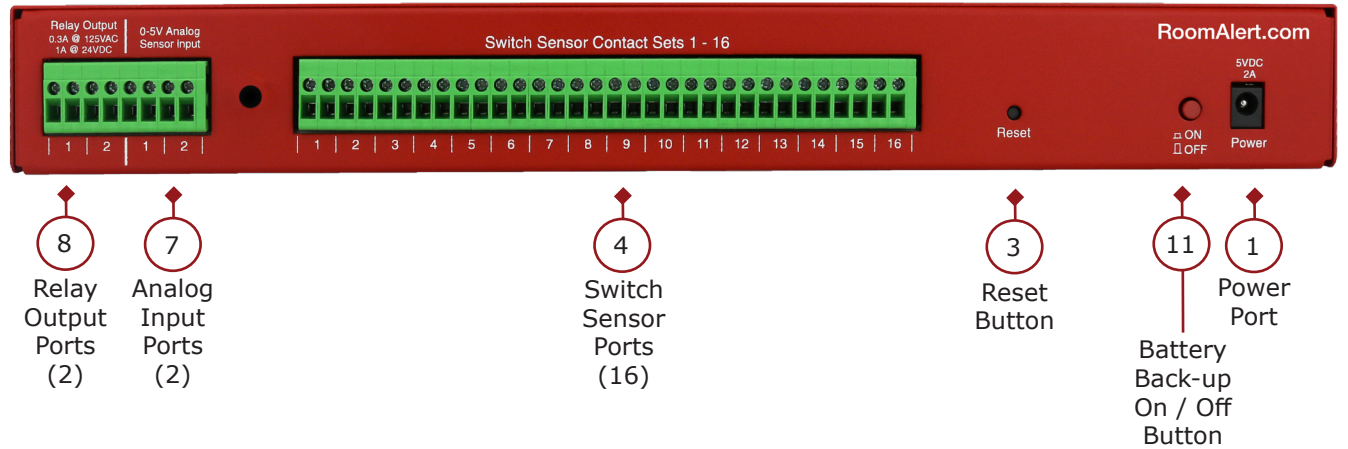

#### Internal Sensors

- Temperature
- Humidity
- Power
- Battery Back-up

## Room Alert 12S

### Front

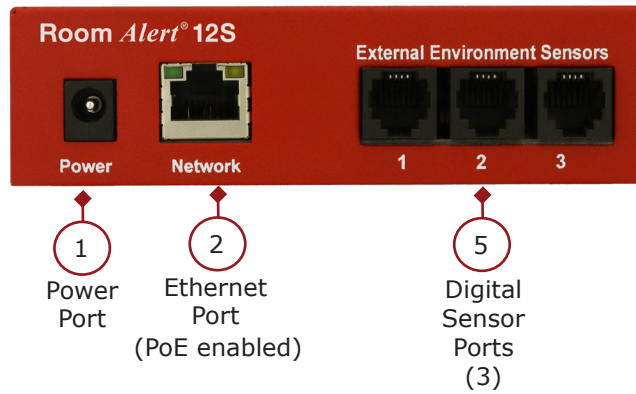



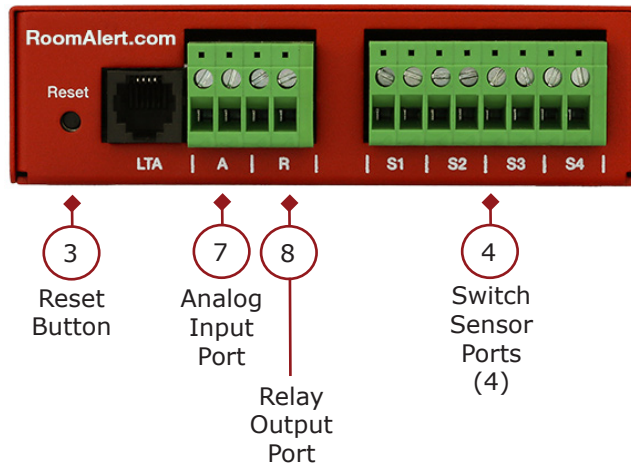



### Back



#### Internal Sensors

- Temperature

## Room Alert Hardware Features

<b>Internal Temperature Sensor</b>	An internal digital sensor monitors ambient temperature with a range of -40° to 185° F (-40° to 85° C).
<b>Internal Humidity Sensor</b>  Room Alert 32S	An internal digital sensor monitors relative humidity with a range of 5% to 95% RH.
<b>Internal Power Sensor</b>  Room Alert 32S	An internal sensor monitors the power state (main power or battery-back up power).
<b>Internal Battery Back-up</b>  Room Alert 32S	An internal battery back-up can power Room Alert 32S for up to 15 minutes.
<b>1 Power Port</b>	A standard power port connects Room Alert to an electrical outlet with any AVTECH 5V 1A Power Adapter. Models are available for all countries.
<b>2 Ethernet Port</b>	An RJ-45 port connects Room Alert to your network via an RJ-45 Ethernet cable.
<b>3 Reset Button</b>	A small push button resets Room Alert to factory default settings. (Please push softly.)
<b>4 Switch Sensor Ports</b>	Dry contacts connect Room Alert to any AVTECH switch sensor or dry contact on a device (e.g., HVAC, generator, pump, fan, etc.) via standard speaker wire or low-voltage 2-wire cable.
<b>5 Digital Ports</b>	Standard RJ-11 jacks connects any AVTECH digital sensor to Room Alert via a standard RJ-11 (straight through) telephone cord.
<b>6 Light Tower &amp; Relay Adapter Port(s)</b>	A standard RJ-11 jack connects a Light Tower & Relay Adapter to Room Alert via a standard RJ11 (straight through) telephone cord.
<b>7 Analog Input Port(s)</b>	Sets of contacts connect any low-voltage analog sensor to your Room Alert via standard speaker wire.
<b>8 Relay Output Port(s)</b>	Sets of contacts connect any low-voltage device to your Room Alert via standard speaker wire.
<b>9 Power Status LED</b>  Room Alert 32S	An LED indicates the power status of Room Alert 32S ( <b>Green</b> = Main or PoE, <b>Red</b> = Internal UPS power).
<b>10 Alarm LEDs</b>  Room Alert 32S	LEDs light red or green to indicate alarm or clear status of Digital or Switch sensors ( <b>Green</b> = Clear, <b>Red</b> = Alarm).
<b>11 Battery Back-up On / Off Button</b>  Room Alert 32S	A push button turns the Room Alert's internal battery back-up on and off.

## **Standard Room Alert Packages**

### **Room Alert 32S**

The standard package includes:

- One (1) Room Alert 32S ID Box
  - One (1) External Digital Active Power Sensor
  - One (1) External Digital Temperature Sensor
  - One (1) AVTECH 5V 1A Power Adapter
  - One (1) Ethernet Cable (10')
- 

### **Room Alert 12S**

The standard package includes:

- One (1) Room Alert 12S ID Box
- One (1) External Digital Active Power Sensor
- One (1) AVTECH 5V 1A Power Adapter
- One (1) Ethernet Cable (10')

## How To Install Your Room Alert S Model

### Connect Your Room Alert Hardware

#### If Your Network Is Power Over Ethernet (PoE) Enabled

- Connect one end of a standard Ethernet cable to the Room Alert's Ethernet port.
- Connect the other end to a PoE-enabled network jack.

*That's it! Your Room Alert is now powered and discoverable on your network.*



#### If Your Network Is Not Power Over Ethernet (PoE) Enabled

##### A. Connect To Your Network First

- Connect one end of a standard Ethernet cable to the Room Alert Ethernet port.
- Connect the other end to a network jack.

##### B. Then Connect To A Power Source

- Plug one end of AVTECH's 5V 1A Power Adapter into the Room Alert power port.
- Plug the other end into a surge-protected power source.



*Your Room Alert is now powered and discoverable on your network!*

### NOTE

Use only AVTECH's 5V 1A Power Adapter. Other voltages could damage the Room Alert hardware and void your warranty. If you don't have an AVTECH 5V 1A Power Adapter, please visit our online store at [AVTECH.com](https://www.avtech.com) to acquire one. Models are available for all countries.

### Connect Included External Sensors And Other Compatible Components

Please install included external sensors and any other compatible components you may have purchased according to their Installation Notes, available at [AVTECH.com](https://www.avtech.com).



## How To Use Room Alert S Model Web Interface

You may configure your Room Alert through its built-in web interface. To access the interface, you may either:

- Type the IP address of your Room Alert monitor directly into the address bar of your web browser.
- Discover your Room Alert monitor with Room Alert Link software, and select its IP address from the *Monitors* list.
- Select your Room Alert monitor in your [RoomAlert.com](https://RoomAlert.com) account and click the **Device Interface** button.

Your Room Alert's web interface has 3 tabs:

- Status
- Settings
- Help

### Status

To view your Room Alert's current sensor status, select **Status** in the navigation bar to the left of your screen.

The screenshot displays the 'Room Alert Monitor' web interface. The top navigation bar is red with the 'Room Alert' logo and a user profile icon. A dark sidebar on the left contains navigation options: Status (selected), Digital Sensors, Switch Sensors, Light Towers & Relays, Analog Sensors, Settings, and Help. The main content area is titled 'Example RA32S' and features a red Room Alert 32S device image. It includes a metadata box with details like Type, MAC, Serial#, Firmware, Local IP, and Power Status (Main Power). An 'Account Status' box shows registration details for 'AVTECH Example' with a 'Professional' upgrade level and 'Enabled' push status. A refresh timer is set to 5 seconds, and temperature units are set to Fahrenheit. The 'Digital Sensors' section is expanded, showing 'Internal Sensor' data (Temperature: 74.30 °F, Humidity: 64.40 %RH, Heat Index: 74.30 °F, Dew Point: 61.50 °F) and 'Ext Sensor 1' data (Temperature: 74.90 °F).

## Banner & Header

### Banner

At the top of the page runs the red Room Alert banner.

**Room Alert® Monitor**



- You may visit [AVTECH.com](https://www.avtech.com) by selecting the AVTECH logo in the banner.

### Header

Below the banner is the header, where you may view basic information about your device.

#### Example RA32S

Type	Room Alert 32S
MAC	A1:B2:C3:D4:E5:F6
Serial#	RA32S-D4E5F6
Firmware	X.X.X 
Local IP	192.168.2.123
Power Status	Main Power



Account Status	
Registered To	AVTECH Example
Account Upgrade Level	Professional
Push is	Enabled
<span>Connected</span> Last Push	2020-03-16T16:29:28Z

03/16/20 16:45:38 

On the left side of the header, you may find the following information:

- Device Name
- Model
- MAC Address
- Serial Number
- Firmware Version
- Local IP Address
- Power Status

On the right side of the header, you may find the following information under *Account Status*:

- The account your Room Alert monitor is registered to in [RoomAlert.com](https://www.roomalert.com).
- Your [RoomAlert.com](https://www.roomalert.com) account level.
- Whether push to [RoomAlert.com](https://www.roomalert.com) is enabled.
- Whether the Room Alert monitor is connected to your [RoomAlert.com](https://www.roomalert.com) account.
- The time & date the Room Alert monitor last pushed sensor data to your [RoomAlert.com](https://www.roomalert.com) account.

## Sensor Display Area

In the main viewing pane of the Status tab is the sensor display area. Here you may view your sensor data and temporarily change Status page settings.

The screenshot shows a digital sensor display interface. At the top, it says "Refresh this page every 5 seconds" and has radio buttons for "Fahrenheit" (selected) and "Celsius". Below this is a section titled "Digital Sensors" with an expandable arrow. It contains two main sensor panels:

- Internal Sensor** (Internal 1: Temperature / Humidity):
  - Temperature: 74.30 °F (range: 74.50 °F to 73.80 °F)
  - Humidity: 64.40 %RH (range: 64.40 %RH to 28.38 %RH)
  - Heat Index: 74.30 °F (range: 74.50 °F to 73.80 °F)
  - Dew Point: 61.50 °F (range: 61.50 °F to 48.00 °F)
- Ext Sensor 1** (External 1: Temperature):
  - Temperature: 74.90 °F (range: 75.00 °F to 74.90 °F)

## Temporary Status Page Settings

You may temporarily change the refresh interval of the Status page and default temperature scale here.

The screenshot shows the settings for the status page. It includes a "Refresh this page every" field with the value "5" and "seconds" next to it. To the right are radio buttons for "Fahrenheit" (selected) and "Celsius".

- To temporarily modify the refresh interval of the Status screen, which is 5 seconds by default, you may enter a value in seconds in the *Refresh this page every X seconds* field. Click outside the field to temporarily commit the change.
- To temporarily toggle the temperature scale between Fahrenheit (F) and Celsius (C), select **Fahrenheit** or **Celsius**.

### Tip

Refer to the [Advanced](#) section in this manual for instructions on setting the default status page refresh rate and temperature scale for Room Alert.

## Alarm Status Icons

Status icons are displayed for sensors that have thresholds set:

- ✔ Green circle with "✓" mark.....Sensor is in a clear state.
- ✘ Red circle with "X" mark.....Sensor is in an alarm state.
- No status icon.....Sensor has no thresholds set.

### **High And Low Reading Icons**

Arrows are displayed next to the highest and lowest readings on a sensor since the Room Alert last rebooted:

- ▲ Red upward arrow .....Highest reading since last reboot of Room Alert.
- ▼ Blue downward arrow.....Lowest reading since last reboot of Room Alert.

### **Navigating The Status Page**

Your Room Alert displays your sensors in the following order:

- Digital Sensors
- Switch Sensors
- Light Towers and Relays
- Built-in Analog Sensors

To navigate to the different types of sensors in the Sensor Display Area, you may scroll down the page or select the sensor category from the navigation bar to the left of your screen.

#### **Note**

Sensors connected to analog input ports and light tower & relay ports do not appear on the Status page until you enable them in the Settings screen. Refer to [Settings](#) in this manual for instructions.

## Settings

### Accessing Settings

To access your Room Alert's settings:

1. Select **Settings** in the navigation bar to the left of your screen.
2. Next, enter your credentials in the *Username* and *Password* fields.
  - If you did not save custom credentials to your Room Alert 32S or 12S already, enter these default credentials:
    - Username: **admin**
    - Password: **password**
  - Then select **Click Here To Access Settings**.

### Navigating Settings

Settings has the following sub-tabs shown in the navigation bar to the left of your screen.

- Sensors
- Alarms
- Network
- Email
- SNMP
- Security
- Advanced

You may navigate to each of these sections by selecting the appropriate sub-tab. Settings opens by default to the Sensor Settings page.

### Saving Settings

To save a setting, click out of the field you just modified and notice that a notification bar appears at the top and bottom of the page.

You have *unsaved settings* in the following sections:

**Sensors, Network, Advanced**

Save Settings

Clear Changes

This notification bar contains the following items:

- A list of Settings pages you have unsaved changes on.

## Room Alert S Models (RA32S-DAP-RAS & RA12S-DAP-RAS)

- A **Save Settings** button.
- A **Clear Changes** button.

You may navigate among the Settings pages, making changes in different places, and then save the changes all at once. When you are ready to save all the modifications you've made, select the **Save Settings** button. Your Room Alert will automatically reboot and commit your changes.

Before you save, if you decide you don't want the changes you just entered, you may re-load the page(s) without them by using the **Clear Changes** button. Settings will re-load without your modifications. The Room Alert does not reboot, and any already-saved settings remain.

## Sensors

Navigate to **Settings** → **Sensors** to open the Sensor Settings screen.

You may configure alert thresholds for your Room Alert’s sensors in this screen. Your Room Alert sends alerts based on these thresholds.

### Note

For more information about AVTECH sensors and accessories, please visit the Sensors and Accessories sections of [AVTECH.com](http://AVTECH.com).

Sensor Label	Alarm On	High	Low	Adjust
Internal Sensor	Temperature (°F)	<input type="checkbox"/> disabled	<input type="checkbox"/> disabled	0
Monitor Heat Index	Humidity	<input type="checkbox"/> disabled	<input type="checkbox"/> disabled	0

Sensor Label	Alarm On	High	Low	Adjust
Ext Sensor 1	Temperature (°F)	<input type="checkbox"/> disabled	<input type="checkbox"/> disabled	0

### Note

Notice the Use Alarm Profile drop-down menu next to each sensor. If you have an AVTECH Light Tower, Relay Switch or built-in relays on your Room Alert, you may configure Alarm Profiles to toggle them on and off when alarms are detected. Please refer to the [Alarms](#) section in this manual for further information.

## Digital Sensor Settings

You may configure alarm thresholds for the digital sensors—both internal and external—in this section.



The Room Alert 32S has an internal temperature sensor and an internal humidity sensor. The Room Alert 12S has an internal temperature sensor.

In the example below, we will configure a Digital Temperature Sensor:

Sensor Label	Alarm On	High	Low	Adjust
Server Rm Temp	Temperature (°F)	<input checked="" type="checkbox"/> 79	<input checked="" type="checkbox"/> 61	0

1. In *Sensor Label*, you may leave the default label, “Internal Sensor” (or “Ext Sensor 1,” etc.) or rename it to something more descriptive, such as “Server Rm Temp.”

**Tip**

Room Alert 32S & 12S sensor labels may be up to 30 characters and can include the following: letters, numbers, spaces, and special characters.

2. The *Alarm On* field automatically fills in—in this case with “Temperature (F).”

**Note**

Refer to the [Advanced](#) section in this manual for instructions on setting the default temperature scale.

3. The *High* and *Low* fields are disabled by default.
  - To enable a High or Low threshold, select the check box in that field.
  - You may then leave the default value or enter a custom temperature threshold.
  - Your Room Alert will generate alerts based on these thresholds.
4. In *Adjust*, you may enter a value to adjust the temperature reading if it differs from a known value at that location.
5. In *Use Alarm Profile*, which controls light towers and relays on your Room Alert, you may leave the default, **Profile 1**, or choose another profile from the drop-down menu.

**Note**

If you have an AVTECH Light Tower, Relay Switch or built-in relays on your Room Alert, you may configure Alarm Profiles to toggle them on and off when alarms are detected. Please refer to the [Alarms](#) section in this manual for further information.

6. Select **Save Settings** at the top or bottom of the page. Your Room Alert will automatically reboot and commit your changes.

**Tip**

The options in the Sensor Alarm Configuration fields vary slightly depending on the type of digital sensor.



## Analog Sensor Settings

You may configure the 0-5 VDC analog sensor connected to your device's built-in analog port(s) in these fields.

In the example below, we are configuring AVTECH's Current Loop 1.

Sensor Label	Alarm On	High	Low	Enabled
Current Loop 1	Analog (Custom Scale)	<input checked="" type="checkbox"/> 6	<input checked="" type="checkbox"/> 2	<input checked="" type="checkbox"/>
Use Alarm Profile:				
Profile 1				
Enabled <input checked="" type="checkbox"/>				
	High	Low		
Reference	5	0		
Scale	10	0		
Unit	Amp			

1. First, enable the sensor by selecting **Enabled** in the set of fields to the right of the sensor configurations. The built-in analog sensor will not appear in the Room Alert web interface, [RoomAlert.com](http://RoomAlert.com) account or SNMP program unless it is enabled.
2. In the set of fields toward the bottom of the sensor configurations, select **Enabled** to turn on the *Reference*, *Scale* and *Unit* fields.
  - In *Reference*, enter values from 5 to 0 that represent the *High* and *Low* points of your analog sensor's output signal range. In the case of the Current Loop 1, which outputs a signal of 0-5 VDC, we've left the default values.
  - In *Scale*, enter the *High* and *Low* points of the scale you want the Reference reading to be converted to. In our Current Loop example, we would like to convert 0-5 volts to 0-10 amps, so we've replaced the default of 5 in *High* with 10 and left the default of 0 in *Low*.
  - In *Unit*, enter a 1 to 3-character label for the unit type that your readings will be measured in. If you are measuring amperage, as with the Current Loop, you might enter "A" or "Amp," for example. Note that this field is merely a label and does not affect any of the calculations.
3. Return to the upper section of the sensor configurations to enter your sensor label and thresholds:
  - In *Sensor Label*, you may leave the default, "Analog 1" or choose something more descriptive, such as "Current Loop 1" or "Cryogenic Temp."

### Tip

Room Alert 32S & 12S sensor labels may be up to 30 characters and can include the following: letters, numbers, spaces, and special characters.

4. The *High* and *Low* fields are disabled by default.

- To enable a High or Low threshold, select the check box in that field.
- You may then leave the default value or enter values that fall within the *Scale* range from the previous step. In our example, we entered a conversion scale of 0 to 10 (amps) in the previous step for the Current Loop, and we've chosen to generate alarms at the high and low thresholds of 6 and 2 (amps).

**Tip**

With the custom scale enabled, you may enter positive and negative whole numbers in High and Low that fall within the Scale range; with the custom scale disabled, you may enter decimal numbers in the range of +/-5.0 (for 0-5 VDC).

- The *Adjust* field is not available if custom scale is enabled. When custom scale is disabled, you may enter a value to adjust the reading if it differs from a known value.

**Tip**

With the custom scale disabled, you may enter decimal numbers in the range of +/-5.0.

5. In *Use Alarm Profile*, which controls light towers and relays on your Room Alert, you may leave the default, **Profile 1**, or choose another Alarm Profile from the drop-down menu.

**Note**

If you have an AVTECH Light Tower, Relay Switch or built-in relays on your Room Alert, you may configure Alarm Profiles to toggle them on and off when alarms are detected. Please refer to the [Alarms](#) section in this manual for further information.

6. Select **Save Settings** at the top or bottom of the page. Your Room Alert will automatically reboot and commit your changes.

**Switch Sensor Settings**

You may configure the alert state for the external switch sensors in the *Switch Sensor Settings* fields. Shown below are the default settings.

The screenshot shows a form titled "Switch Sensor Settings" with three input fields: "Switch 1 Label" containing "Switch Sensor 1", "Alarm On" set to "Closed" with a dropdown arrow, and "Alarm Profile" set to "Profile 1" with a dropdown arrow.

## Room Alert S Models (RA32S-DAP-RAS & RA12S-DAP-RAS)

Your Room Alert monitors your switch sensors for an “Open” or “Closed” circuit state. Room Alert defaults to alarming on “Closed,” as you can see above; you may, however, need to change that depending on your sensor. AVTECH’s Motion Sensor, for example, is “Open” when it detects movement and “Closed” when it doesn’t; in that case, you’d likely want to configure the sensor to alarm on “Open” or when motion is detected.

### **The Alarm And Clear State Of Your Switch Sensor**

To determine the alarm and clear state of your sensor, you may either refer to its Installation Note or see for yourself by physically connecting your sensor to your Room Alert and then observing what happens to its circuit state in the Status page.

After you connect your sensor and before you configure it in the Settings page, follow these steps:

1. Select the **Status** tab in the navigation bar to the left of your screen.
2. Scroll down to the Switch Sensors and look at the circuit state of the channel you connected your sensor to. If you connected your sensor to the first switch sensor port on Room Alert, look at Channel 1; if you connected it to the second, look at Channel 2, etc.

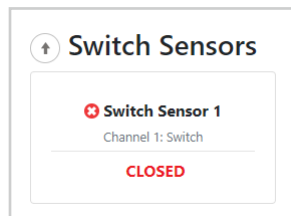

3. Notice the circuit state of Switch 1. It should show the normal state, which in this case is “Closed.” (Ignore the red color coding for now. We haven’t configured the sensor yet, so it’s still set at the default: alarm on closed.)
4. Now put the sensor into an alarm state. To put a Motion Sensor into an alarm state, for example, wave your hand in front of it.
5. Look at the circuit state at the same time. You should see it switch to the opposite of normal. In this example, if normal is “Closed,” you see the alarm state as “Open.” (Again, ignore the green color coding for now.)

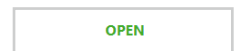

Now that you’ve checked what “Open” and “Closed” mean on your switch sensor, navigate to **Settings** → **Sensors** to configure your options in *Switch Sensor Settings*:

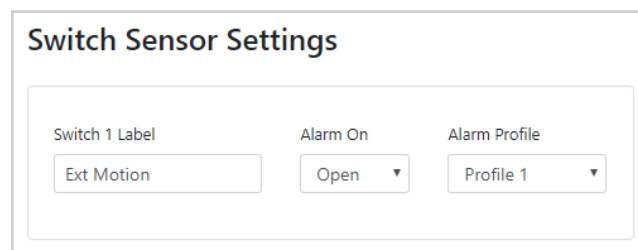

## Room Alert S Models (RA32S-DAP-RAS & RA12S-DAP-RAS)

1. In *Sensor Label*, you may leave the default, "Switch Sensor 1" (2, 3 or 4, etc.) or enter something more descriptive, such as "Ext Motion" or "Main Entry."

### Tip

Room Alert 32S & 12S sensor labels may be up to 30 characters and can include the following: letters, numbers, spaces, and special characters.

2. In *Alarm On*, select the alarm state (**Open** or **Closed**). In our example, the alarm state is **Open**.
3. In *Alarm Profile*, which controls light towers and relays on your Room Alert, you may leave the default, **Profile 1**, or choose another Alarm Profile from the drop-down menu.

### Note

If you have an AVTECH Light Tower, Relay Switch or built-in relays on your Room Alert, you may configure Alarm Profiles to toggle them on and off when alarms are detected. Please refer to the [Alarms](#) section in this manual for further information.

4. Select **Save Settings** at the top or bottom of the page. Your Room Alert will automatically reboot and commit your changes.

### Tip

For any of the switch sensor sets you leave unused on your Room Alert, choose **Disabled** from the *Alarm On* drop-down menu to avoid confusion or false alerts.

## Internal Power Sensor Alarm Configuration (📶 Room Alert 32S)

You may configure the power sensor that is built in to the Room Alert 32S here. This internal power sensor triggers on loss of main power and can send a notification while the battery back-up keeps the Room Alert monitor powered for a short time.

### Internal Power Sensor Alarm Configuration

Internal Power Sensor 1 Label	Alarm On	Alarm Profile
<input type="text" value="Power Sensor"/>	<input checked="" type="checkbox"/> Power Loss	<input type="text" value="Profile 1"/>

1. In *Internal Power Sensor Label*, you may leave the default "Power Sensor" or enter something more descriptive, such as "RA32S Power."

### Tip

Room Alert 32S sensor labels may be up to 30 characters and can include the following: letters, numbers, spaces, and special characters.

2. In *Alarm On Power Loss*, you may leave the checkbox filled in if you wish to receive an alert when your Room Alert 32S loses its main power source. Otherwise, you may uncheck it.

## Room Alert S Models (RA32S-DAP-RAS & RA12S-DAP-RAS)

3. In *Alarm Profile*, which controls light towers and relays on your Room Alert, you may leave the default, **Profile 1**, or choose another Alarm Profile from the drop-down menu.

### Note

If you have an AVTECH Light Tower, Relay Switch or built-in relays on your Room Alert, you may configure Alarm Profiles to toggle them on and off when alarms are detected. Please refer to the [Alarms](#) section in this manual for further information.

4. Select **Save Settings** at the top or bottom of the page. Your Room Alert will automatically reboot and commit your changes.

## Alarms

Navigate to **Settings** → **Alarms** to open the *Alarm Settings* screen. Here you may configure light towers and relays.

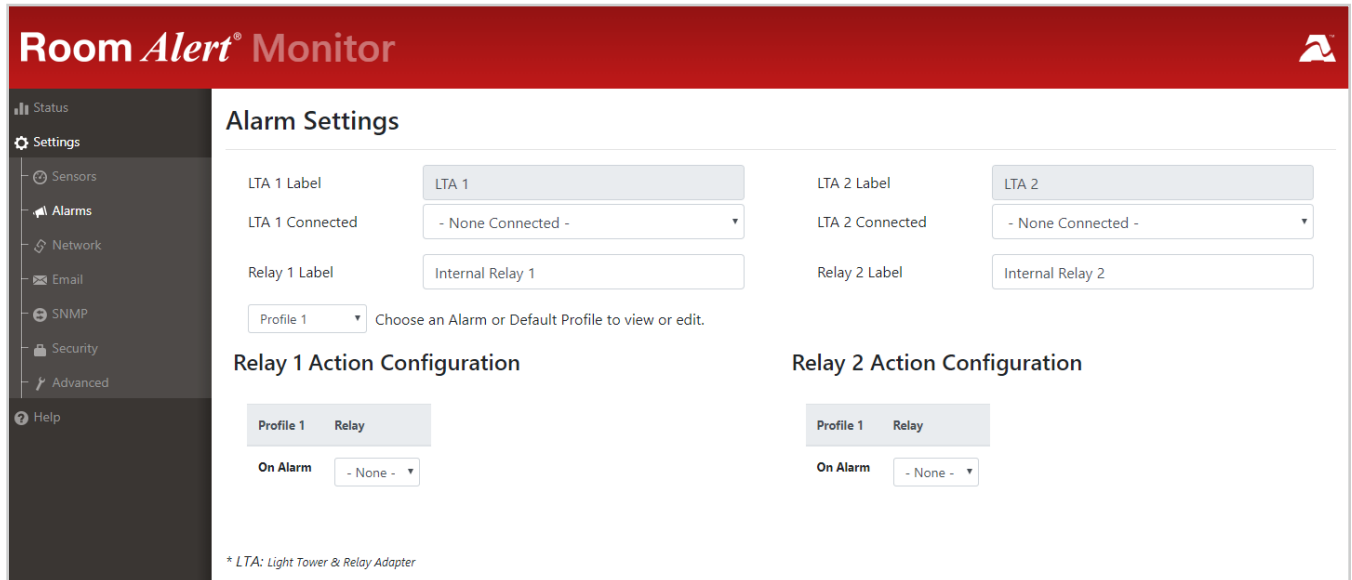

### Light Tower/Relay Profile Configuration

In this example, we'll select and name a Light Tower w/Audio in *LTA 1* and then configure its Profile 1.

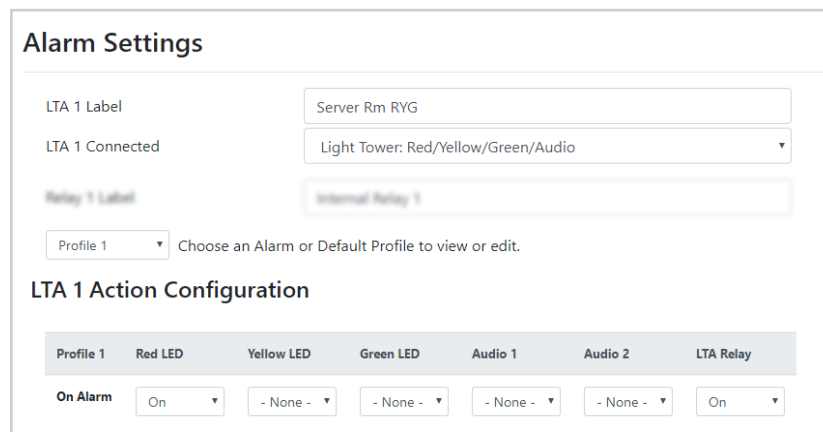

1. In *LTA 1 Label*, you may leave the default, "LTA 1" or enter something more descriptive, such as "Server Rm RYG."
2. In *LTA 1 Connected*, select the appropriate option from the choices in the drop-down menu. For this example, we are choosing **Light Tower: Red/Yellow/Green/Audio** for the Light Tower w/Audio.
3. Once you choose your device, the Alarm Profile configuration grid beneath it expands. Notice that all features are set to **-None-** by default.

**Tip** The features available vary depending on the device you've selected.

4. Choose the Profile you wish to configure in the *Profile* drop-down list. Depending on your model, you may have up to 5 available Profiles, plus a "Default" profile where you can configure the built-in Relay's default behavior.



The Room Alert 32S offers a "Default" profile plus 5 additional profiles. The Room Alert 12S offers a "Default" profile plus 3 additional profiles.

### ***Light Tower & Relay Adapter (LTA)***

A Light Tower & Relay Adapter gives you the option to add an AVTECH Light Tower, Light Tower w/Audio or Relay Switch to your Room Alert. You may also connect a low-voltage device directly to the built-in relay port on the Light Tower & Relay Adapter.

Shown here is a sample configuration:



### **Note**

The Light Tower w/Audio in this configuration can be replaced with a standard Light Tower or Relay Switch. For more information about AVTECH sensors and accessories, please visit the Sensors & Accessories sections of AVTECH.com.

## Relay Action Configuration

Here you may set the devices connected through the built-in relay output port(s) to turn on or off in response to your Room Alert sensors going in and out of alarm state.

In this example, we'll configure Relay 1.

Relay 1 Label	Server Rm AC
Profile 1	Choose an Alarm or Default Profile to view or edit.
<b>Relay 1 Action Configuration</b>	
Profile 1	Relay
On Alarm	On

1. In *Relay 1 Label*, you may leave the default, "Internal Relay 1," or enter something more descriptive, such as "Server Rm AC."

### Tip

Room Alert 32S & 12S relay labels may be up to 30 characters and can include the following: letters, numbers, spaces, and special characters.

2. Choose the Profile you wish to configure in the Profile drop-down list. Depending on your model, you may have up to 5 available Profiles, plus a "Default" profile where you can configure the built-in Relay's default behavior.



The Room Alert 32S offers a "Default" profile plus 5 additional profiles. The Room Alert 12S offers a "Default" profile plus 3 additional profiles.

## Associate Alarm Profiles With Sensors

Each sensor is set at Profile 1 by default; connected light towers, built-in LTA relays, Relay Switches and built-in relay outputs execute Profile 1 when that sensor goes into an alarm state.

You may associate a profile with a sensor by following the steps below. In this example from our Room Alert 32S, you can see we have 5 profiles to choose from:

1. Navigate to **Settings** → **Sensors**.
2. Find your sensor's interface and choose the profile you've configured from the drop-down list in *Use Alarm Profile*.



## Room Alert S Models (RA32S-DAP-RAS & RA12S-DAP-RAS)

- Note that the default for all sensors is **Profile 1**. You may also choose **No Alarm** if you do not want to associate your sensor with a profile.

Sensor Label	Alarm On	High	Low
Server Rm Tem	Temperature (°F)	<input checked="" type="checkbox"/> 78	<input checked="" type="checkbox"/> 60

- Select **Save Settings** at the top or bottom of the page. Your Room Alert will automatically reboot and commit your changes.

### Tip

Alarm Profiles affect only light towers and relays; they do not affect email alerts.

## Network

Navigate to **Settings** → **Network** to open the *Network Settings* screen.

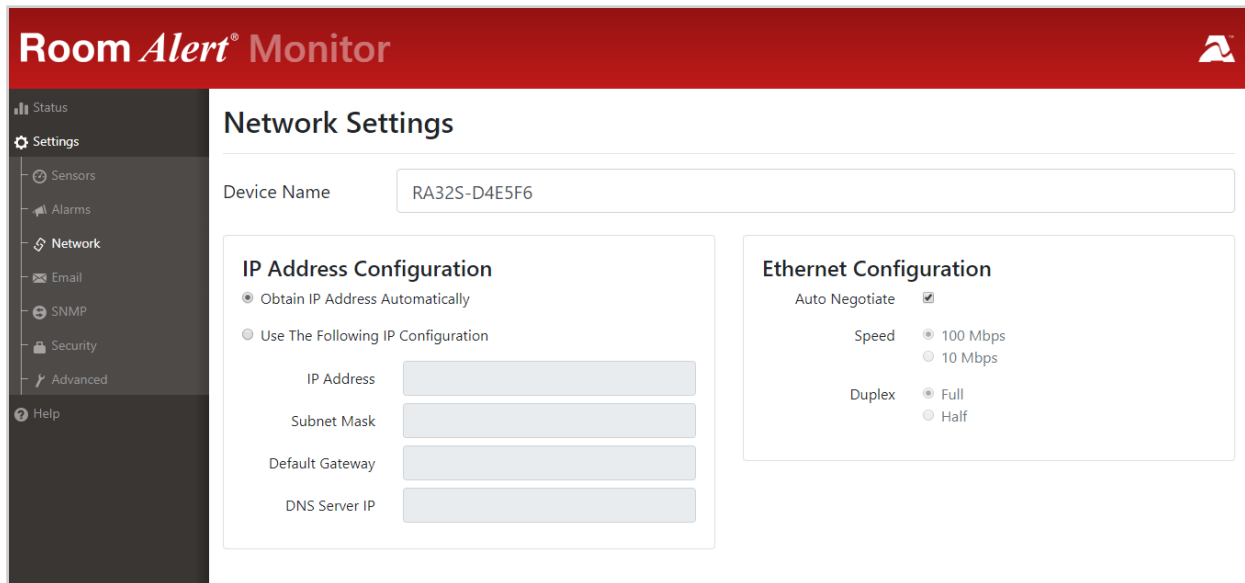

### Device Name

To rename your Room Alert:

1. Select the automatically-assigned name in *Device Name* and enter a new one of up to 30 characters.

#### Tip

Room Alert 32S & 12S device names may be up to 30 characters and can include the following: letters, numbers, spaces, and special characters.

2. Select **Save Settings** at the top or bottom of the page. Your Room Alert will automatically reboot and commit your changes.

### IP Address Configuration—DHCP

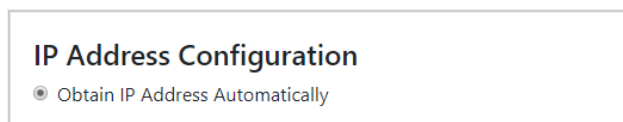

To obtain an IP address automatically using DHCP:

1. Select **Obtain IP Address Automatically**, which is the default setting.
2. Select **Save Settings** at the top or bottom of the page. Your Room Alert will automatically reboot and commit your changes.

### **IP Address Configuration—Static IP**

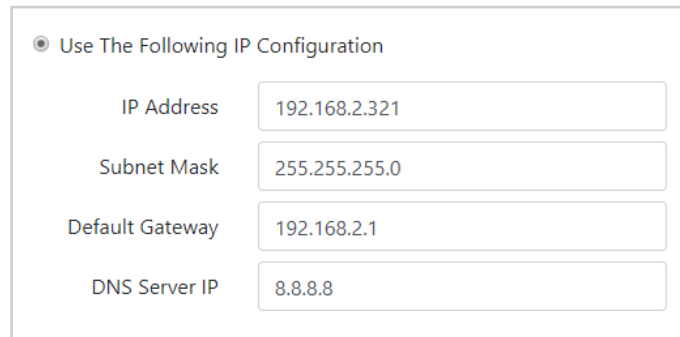

The screenshot shows a configuration form titled "Use The Following IP Configuration". It contains four input fields: "IP Address" with the value "192.168.2.321", "Subnet Mask" with "255.255.255.0", "Default Gateway" with "192.168.2.1", and "DNS Server IP" with "8.8.8.8".

To assign a static IP address:

1. Select **Use The Following IP Configuration**.
2. In *IP Address*, enter the new static IP address.
3. In *Subnet Mask*, enter the subnet mask.
4. In *Default Gateway*, enter the gateway IP address.
5. In *DNS Server IP*, enter the DNS server IP address.
6. Select **Save Settings** at the top or bottom of the page. Your Room Alert will automatically reboot and commit your changes.

#### **Tip**

Make sure that you do not use an IP address that is already assigned to another device. Also, set the IP address within your current subnet range; otherwise, you may not be able to discover your Room Alert.

### **Ethernet Configuration**

Typically, you may leave the Ethernet Configuration section at the defaults, which are shown below.

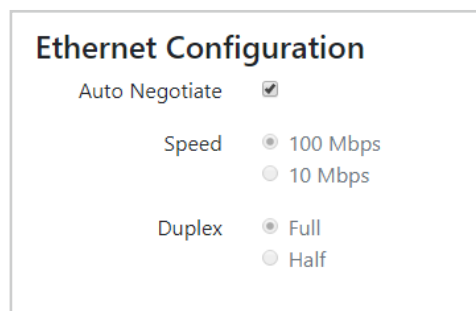

The screenshot shows the "Ethernet Configuration" section. It includes a checked checkbox for "Auto Negotiate". Below it are two radio button options for "Speed": "100 Mbps" (selected) and "10 Mbps". At the bottom are two radio button options for "Duplex": "Full" (selected) and "Half".

However, if you connect your Room Alert to a managed switch that controls your network traffic, you may need to change these settings:

Room Alert S Models (RA32S-DAP-RAS & RA12S-DAP-RAS)

1. You may uncheck **Auto Negotiate** and choose:
  - For *Speed*, **100 Mbps** or **10 Mbps**.
  - For *Duplex*, **Full** or **Half**.
2. Select **Save Settings** at the top or bottom of the page. Your Room Alert will automatically reboot and commit your changes.

## Room Alert S Models (RA32S-DAP-RAS & RA12S-DAP-RAS)

### Email

You may configure your Room Alert to send alerts via email and email-to-SMS.

Navigate to **Settings** → **Email** to open the Email Settings screen.

1. Check **Email Enabled**.
2. You may leave **Email Footer Enabled** checked to include AVTECH contact information with email messages.
3. You may check **Use Short Message** to send a shorter email with a reduced character count.

4. In *Mail Server*:

- In *Domain Name/IP*, enter the domain name or IP address of your mail server.
- In *Secure Connection*, select the checkbox if your mail server requires SSL or TLS encryption.
- In *Port*, enter your mail server's SMTP port. The default is 25, a commonly-used port.
- In *Timeout*, you may leave the default, 30 seconds, or enter another interval.

5. In *Return Address*, enter an email address that resides on your mail server. This is the address alert messages will come from.

6. In *Email Recipients*, enter the email and email-to-SMS addresses that you'd like to send alerts to. Separate each address with a comma. (Do not enter spaces after the commas.)

- Email address: ITMgr@Example.com
- Email-to-SMS address: 1235551900@ATT.txt.net
- Addresses separated by commas: ITMgr@Example.com,1235551900@ATT.txt.net, etc.

7. The *Device URL* field controls what IP or URL displays in email alerts. You may leave the default, a disabled, blank field, or enter a custom IP address or URL. To make a custom entry, you must first check **Device URL Enabled**.

- When this field is left at the default (disabled, blank), your email alerts will contain the Room Alert's current IP address and HTTP or HTTPS port number in the body of the email.
- When this field is overwritten with a custom IP or URL, your email alerts will contain that custom IP or URL in the body of the email.

**Authentication (Optional)**

8. If your mail server requires SMTP authentication, check **Enable Authentication**.

9. In *Username*, enter a valid username for your mail server that will facilitate authentication.

10. In *Password*, first select the **Change** button to enable the field. Then enter a valid password for your mail server that will facilitate authentication.

11. Select **Save Settings** at the top or bottom of the page. Your Room Alert will automatically reboot and commit your changes.

When your Room Alert reboots, return to the *Email Settings* screen and select **Send Test Email** to send a test email to the addresses you entered in *Email Recipients*.

## Simple Network Management Protocol (SNMP)

Because your Room Alert is fully SNMP-compliant, you have the option to monitor it with a 3<sup>rd</sup>-party monitoring application capable of performing SNMP queries. You may configure Room Alert to send SNMP Traps in response to a change in alarm states to up to three host systems running 3<sup>rd</sup>-party SNMP monitoring applications.

If you use a 3<sup>rd</sup>-party SNMP monitoring application:

- Obtain the Room Alert MIB files and load them into your SNMP monitoring application. Otherwise, your application cannot properly translate the data it receives in the SNMP Trap.
- Determine if your application uses SNMPv1, v2c, or v3.
- Note that your Room Alert communicates with your SNMP monitoring application using the standard port for the SNMP protocol, 161.

Navigate to **Settings** → **SNMP** to open the SNMP Settings screen.

**Room Alert<sup>®</sup> Monitor**

### SNMP Settings

**General SNMP Configuration**

MIB File: [Download SNMP MIB File](#)

Use 2 Digit SNMP

Use SNMPv3

[How To Find SNMP Values For Room Alert Sensors](#)

**SNMPv1/SNMPv2c Configuration**

Community Name:

Contact (sysContact):

Location (sysLocation):

**SNMP Trap Sending Configuration**

Trap Send IP 1:

Trap Send IP 2:

Trap Send IP 3:

### General SNMP Configuration

1. Select **Download SNMP MIB File** to download the Room Alert MIB files.
2. You may select **Use 2 Digit SNMP** if you prefer to receive values in 2-digit rather than 4-digit format.

**Tip**

Room Alert sends values to your 3<sup>rd</sup>-party SNMP monitoring application in 4-digit format by default. 78.55° F, for example, appears as 7855. In 2-digit format, your values are truncated, not rounded to the nearest number. In this example, 78.55 would appear as 78.

3. If your SNMP monitoring application uses SNMPv3, select **Use SNMPv3**; otherwise, leave this box un-checked.

**SNMP Configuration v1 &v2c**

To begin configuring your Room Alert for SNMP v1 or v2c:

1. In *Community Name*, you may leave the default SNMP protocol community name, "public," or enter a new name.

**Tip**

The community name you assign here must match the one in your 3<sup>rd</sup>-party SNMP monitoring application.

2. You may leave *Contact (sysContact)* blank or enter a person's name to specify who is receiving the information.
3. You may leave *Location (sysLocation)* blank or enter the location of your Room Alert monitor.
4. Select **Save Settings** at the top or bottom of the page. Your Room Alert will automatically reboot and commit your changes.

**SNMP Configuration v3**

After you select **Use SNMPv3**, you'll see new options appear on the SNMP Settings page. To begin configuring your Room Alert for SNMP v3:

1. Select a *Security Level* from the drop-down menu. The default is No authentication or privacy.

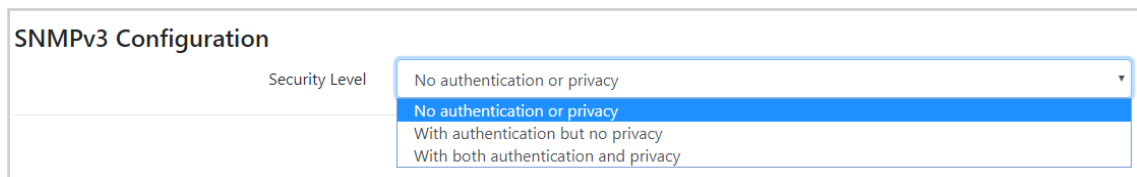

The screenshot shows a form titled "SNMPv3 Configuration". It contains a label "Security Level" next to a dropdown menu. The dropdown menu is open, showing four options: "No authentication or privacy" (which is highlighted in blue), "With authentication but no privacy", and "With both authentication and privacy".

2. If you select **With authentication but no privacy** or **With authentication and privacy**, you'll see some or all of these additional fields:
  - In *Username*, enter the username that's configured in your SNMP monitoring program.
  - In *Authorization Protocol*, select the protocol that your SNMP monitoring program is



## Room Alert S Models (RA32S-DAP-RAS & RA12S-DAP-RAS)

configured to use. The default is *HMAC MD5 authentication protocol*.

- In *Authentication Password*, enter the authentication password that's configured in your SNMP monitoring program.
- In *Privacy Password*, enter the privacy password that's configured in your SNMP monitoring program.

### SNMPv3 Configuration

Security Level	<input type="text" value="With both authentication and privacy"/>
Username	<input type="text"/>
Authorization Protocol	<input type="text" value="HMAC MD5 authentication protocol"/>
Authorization Password	<input type="text"/> <small>Max length: 20 characters</small>
Privacy Password *	<input type="text"/> <small>Max length: 16 characters * Advanced Encryption Standard (AES-CFB) protocol</small>

3. Select **Save Settings** at the top or bottom of the page. Your Room Alert will automatically reboot and commit your changes.

### **SNMP Trap Sending Configuration**

You may configure your Room Alert to send SNMP Traps in response to a change in alarm state to up to three host systems running 3rd-party SNMP monitoring applications. Each host system you enter in these fields will receive the same SNMP Traps simultaneously.

### SNMP Trap Sending Configuration

Trap Send IP 1	<input type="text" value="0.0.0.0"/>
Trap Send IP 2	<input type="text" value="0.0.0.0"/>
Trap Send IP 3	<input type="text" value="0.0.0.0"/>

To configure your Room Alert to send SNMP Traps:

1. In *Trap Send IP 1*, enter the IP address of the host system that runs your 3<sup>rd</sup>-party SNMP monitoring application.
2. In *Trap Send IP 2* and *Trap Send IP 3*, you may enter the IP addresses of other host systems that run 3<sup>rd</sup>-party SNMP monitoring applications, or leave the default, 0.0.0.0.
3. Select **Save Settings** at the top or bottom of the page. Your Room Alert will automatically reboot and commit your changes.

Room Alert S Models (RA32S-DAP-RAS & RA12S-DAP-RAS)

## Security

The username and password on your Room Alert 32S &12S protect all of its *Settings* pages.

### **Default Credentials**

By default, your Room Alert has these credentials:

- Username: **admin**
- Password: **password**

### **Custom Credentials**

Navigate to **Settings** → **Security** to open the *Security Settings* screen.

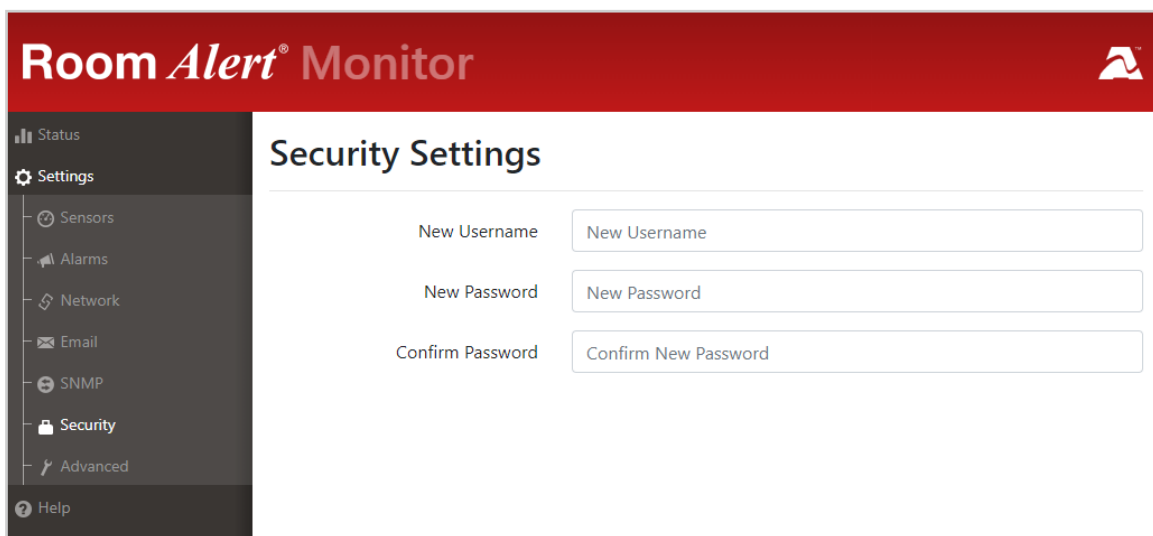

The screenshot shows the 'Room Alert Monitor' interface. The top header is red with the product name and logo. A dark sidebar on the left contains navigation options: Status, Settings (selected), Sensors, Alarms, Network, Email, SNMP, Security, Advanced, and Help. The main content area is titled 'Security Settings' and contains three input fields: 'New Username' with the placeholder 'New Username', 'New Password' with the placeholder 'New Password', and 'Confirm Password' with the placeholder 'Confirm New Password'.

To set custom credentials,

1. In *New Username*, you may create a username of up to 50 characters.
2. In *New Password*, you may create a password of up to 50 characters.
3. Re-enter the password in the *Confirm Password* field to verify.
4. Select **Save Settings** at the top or bottom of the page. Your Room Alert will automatically reboot and commit your changes.

## Advanced

You may configure a number of advanced options here, including Status screen defaults, time & date, trace output and push to [RoomAlert.com](http://RoomAlert.com).

Navigate to **Settings** → **Advanced** to open the *Advanced Settings* screen.

**Room Alert Monitor**

### Advanced Settings

**General**

Status Page Refresh Rate (seconds)

Custom Web Port

Web Port

Enable HTTPS

Temperature Scale

**Date & Time Configuration**

Time Zone

Time Display

Time Format

Enable Daylight Saving  Adjust for daylight saving time (+1 hr)

**Time Server**

Use custom time server  (if this is disabled [time.nist.gov](http://time.nist.gov) will be used by default)

Domain Name/IP

Auto Refresh

**Trace Configuration**

Enable

Port

**RoomAlert.com**

Enable push to RoomAlert.com

Send current data to RoomAlert.com

**Reset to Defaults**

## General

In the *General* section, you may set defaults for the *Status* screen:

- In *Status Page Refresh Rate (seconds)*, enter the number of seconds you would like

## Room Alert S Models (RA32S-DAP-RAS & RA12S-DAP-RAS)

the *Status* screen to refresh at. You may enter a value from 1 to 255. The default is 5 seconds.

- In *Web Port*, you may change the port number your web browser uses to connect to your Room Alert's web interface. By default, it uses port 80 for HTTP and port 443 for HTTPS.
- To change the web port, select the **Custom Web Port** checkbox above the *Web Port* field.
- Select the **Enable HTTPS** checkbox to enable your Room Alert to use HTTPS for its local web interface. When enabled, your Room Alert Monitor's local web interface is secured by an SSL certificate issued to \*.roomalertmonitor.com.
- In *Temperature Scale*, you may choose **Fahrenheit** or **Celsius** from the drop-down list. **Fahrenheit** is the default.

### **Date & Time Configuration**

In *Date & Time Configuration*, you may configure the date and time defaults for your Room Alert.

- In *Time Zone*, select your time zone from the drop-down list. (GMT) Greenwich Mean Time is the default.
- In *Time Display*, you may select the AM/PM or 24 hour format from the drop-down list. The 24 hour setting is the default.
- In *Time Format*, you may select either the MM/DD/YY or DD/MM/YY date format from the drop-down list. Month first (MM/DD/YY) is the default.
- Select **Enable Daylight Savings** if you would like your Room Alert time setting to compensate by +1 hour for daylight savings time.

### **Time Server**

By default, Room Alert uses the Network Time Protocol (NTP) server, time.nist.gov. In the *Time Server* sub-section, you may choose to use a custom time server.

- To use a different time server, select the **Use custom time server** checkbox.
- In *Domain Name/IP*, enter your time server's domain name or IP address.
- In *Auto Refresh*, you may select how often Room Alert automatically synchronizes with your time server. You may leave the default, 24 Hours, or choose another interval, as frequent as 10 minutes, from the drop-down list.

### **Trace Configuration**

You may configure your Room Alert for trace output, which is useful for troubleshooting.

Trace output shows the communication between your Room Alert and your mail server, as well as other information, such as the current firmware version, IP address, MAC address, and requests to web pages.

## Room Alert S Models (RA32S-DAP-RAS & RA12S-DAP-RAS)

- To configure trace output, first select **Enable**.
- In *Port*, you may leave the default port, 143, or enter another port number.

You may then use any standard telnet or terminal application to view the trace on the configured port.

### **RoomAlert.com**

Room Alert Monitors with push to [RoomAlert.com](https://RoomAlert.com) enabled automatically update your Room Alert Account with sensor data at defined intervals.

- Push to [RoomAlert.com](https://RoomAlert.com) is enabled by default.
- If you wish to disable push to [RoomAlert.com](https://RoomAlert.com), un-check the **Enable push to RoomAlert.com** box.
- Select **Send Push** to manually send sensor data to [RoomAlert.com](https://RoomAlert.com).

When you're done making changes in the *Advanced Settings* page, select **Save Settings** at the top or bottom of the page. Your Room Alert will automatically reboot and commit your changes.

### **Reset to Defaults**

At the bottom of the Advanced Settings page, you'll find the **Reset To Factory Defaults** button.

Resetting to defaults removes all of your custom settings, including sensor thresholds, static IP address settings and password security.

To reset your device to defaults:

1. Select the **Reset To Factory Defaults** button.
2. In the confirmation box that appears, select **Reset Now** to proceed with the reset process, or select **Cancel** to close the window.

Room Alert S Models (RA32S-DAP-RAS & RA12S-DAP-RAS)

## For More Information...

### Visit our Support Center.

Go to <https://AVTECH.com/Support/> to view our collection of:

- [Frequently Asked Questions](#)
- [Installation Notes](#)
- [Product Tours](#)
- and more

### Find us on YouTube.

Go to the [AVTECH Software, Inc. YouTube Channel](#), and let us walk you through the steps to configure alerts & reports for your Room Alert Monitors—and so much more.

### Common Questions

[How To Discover A Room Alert Monitor](#)

[How To Update Firmware On Room Alert Monitors](#)

[How To Reset A Room Alert Monitor To Factory Defaults](#)

[How To Create Alerts In Your RoomAlert.com Account](#)

[How To Create A Report In Your RoomAlert.com Account](#)

AVT-200701-1.1.0